

FEATURES

- Plastic package has Underwriters Laboratory Flammability Classification 94V-0
- Metal silicon junction ,majority carrier conduction
- Guard ring for overvoltage protection
- Low power loss ,high efficiency
- High current capability ,Low forward voltage drop
- High surge capability
- For use in low voltage ,high frequency inverters, free wheeling ,and polarity protection applications
- Dual rectifier construction
- High temperature soldering guaranteed:260° C/10 seconds, 0.25"(6.35mm)from case
- Component in accordance to RoHS 2002/95/EC and WEEE 2002/96/EC

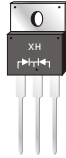

TO-220AB

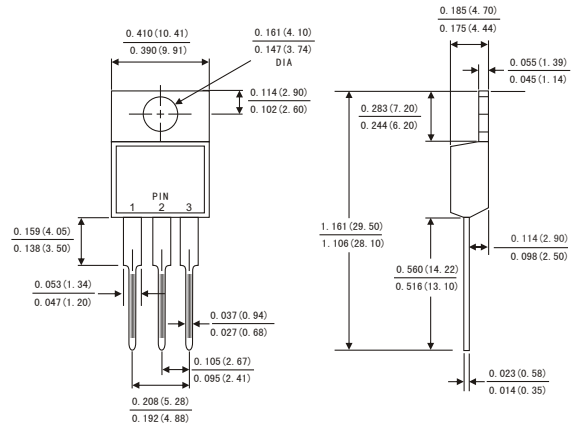

MECHANICAL DATA

- Case: JEDEC TO-220AB molded plastic body
- Terminals: Lead solderable per MIL-STD-750,method 2026
- Polarity: As marked
- Mounting Position: Any
- Weight: 0.08ounce, 2.24 grams

Dimensions in inches and (millimeters)

MAXIMUM RATINGS AND ELECTRICAL CHARACTERISTICS

(Ratings at 25°C ambient temperature unless otherwise specified ,Single phase ,half wave ,resistive or inductive load. For capacitive load,derate by 20%.)

	Symbols	MBR 2020LCT	MBR 2030LCT	MBR 2040LCT	MBR 2050LCT	MBR 2060LCT	MBR 2080LCT	MBR 20100LCT	MBR 20150LCT	MBR 20200LCT	Units
Maximum repetitive peak reverse voltage	V _{RRM}	20	30	40	50	60	80	100	150	200	Volts
Maximum RMS voltage	V _{RMS}	14	21	28	35	42	56	70	105	140	Volts
Maximum DC blocking voltage	V _{DC}	20	30	40	50	60	80	100	150	200	Volts
Maximum average forward rectified current(see Fig.1)	Per leg	10.0									Amps
	Total device	20.0									
Peak forward surge current 8.3ms single half sine-wave superimposed on rated load (JEDEC method)	I _{FSM}	200.0									Amps
Maximum instantaneous forward voltage at 20.0 A	V _F	0.45		0.55		0.70		0.85		Volts	
Maximum instantaneous reverse current at rated DC blocking voltage(Note 1)	T _c = 25°C	0.2									mA
	T _c = 125°C	30			50						
Typical thermal resistance (Note 2)	R _{θJC}	3.0									°C/W
Operating junction temperature range	T _J	-65 to +150									°C
Storage temperature range	T _{STG}	-65 to +150									°C

- Notes: 1. Pulse test: 300 μs pulse width, 1% duty cycle
2. Thermal resistance from junction to case

FIG.1-FORWARD CURRENT DERATING CURVE

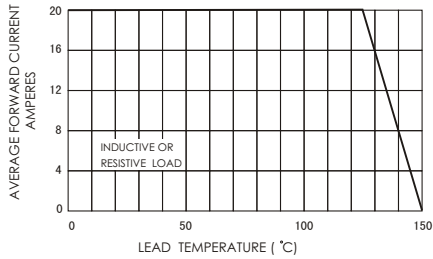

FIG.2-MAXIMUM NON-REPETITIVE PEAK FORWARD SURGE CURRENT

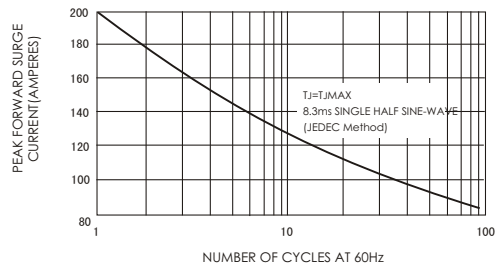

FIG.3-TYPICAL INSTANTANEOUS FORWARD CHARACTERISTICS

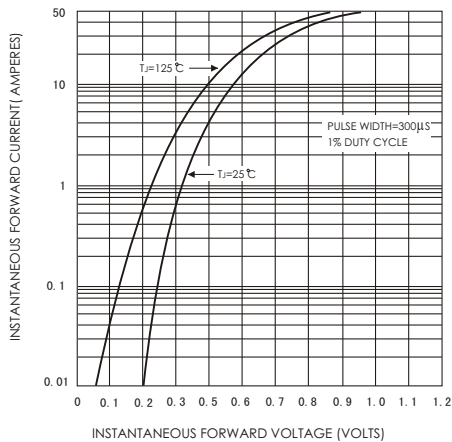

FIG.4-TYPICAL REVERSE CHARACTERISTICS

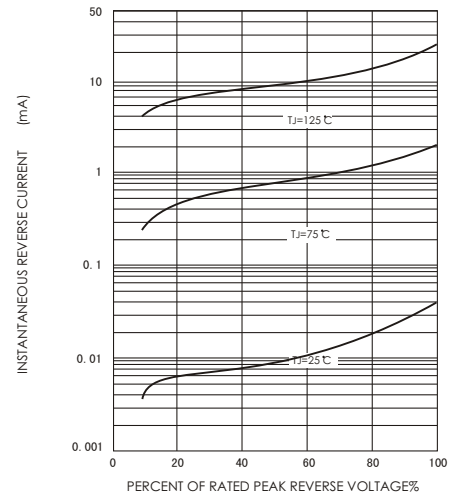

FIG.5-TYPICAL JUNCTION CAPACITANCE

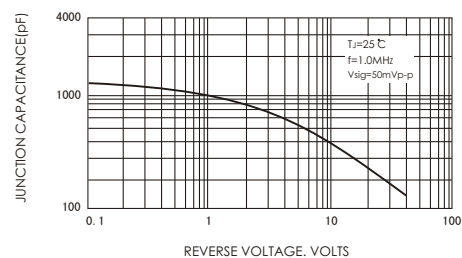

FIG.6-TYPICAL TRANSIENT THERMAL IMPEDANCE

